

PROGRAMMING MANUAL

Koro

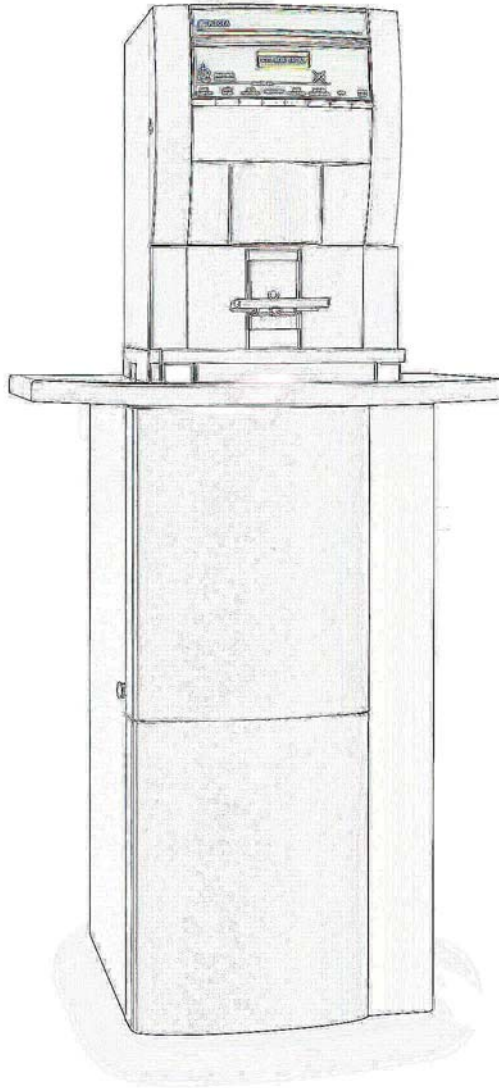

Rev 1.0

English

Code:

P 252 rev. 1.0

Date:

09 - 2005

Programming Menu summary

Necta's vending machines can function in 3 different operating modes:

- **Normal vending mode**
- **Filler menu**
- **Technician menu**

In order to access the programming menus, press the programming button located on the coin mechanism compartment:

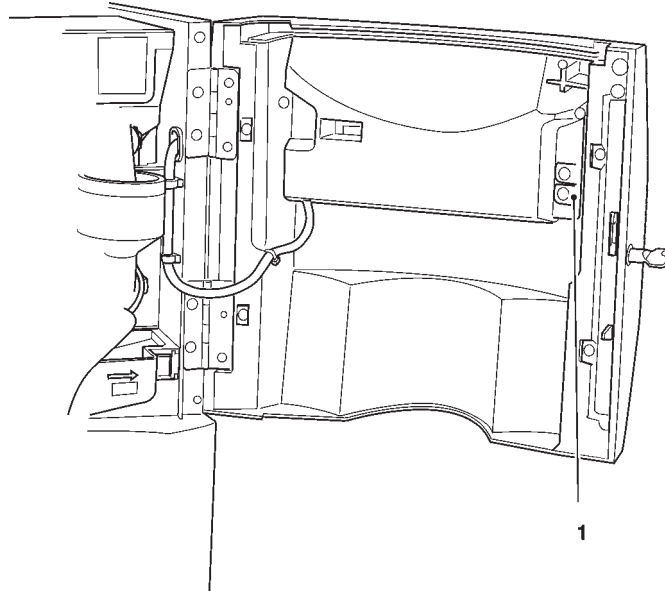

At this point the machine goes into Filler Menu mode.

The buttons shown in the figure are used for surfing through the different menus:

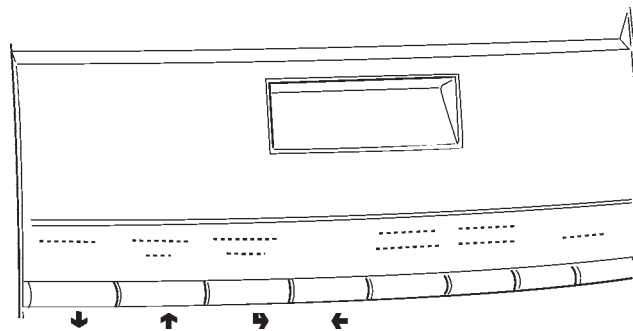

Scrolling buttons **UP** (↑) and **DOWN** (↓)

The UP and DOWN scrolling buttons are used for moving from one programming menu item to the the next one, located in the same level, and at the same time change the status or the numeric value of the corresponding functions.

Confirm / Enter button (↵)

The confirm / enter button is used for moving to the lower level or for confirming a value after being entered or changed.

Exit button (←)

The exit button is used for returning to the higher level or for exiting a change field of a function. When reaching the highest level in the menu, this button is pressed for going from the Technician menu into the Filler menu and vice versa.

1 STATISTICS

1.1 STATIS. PRINTING

1.1.1 PARTIAL PRINTING

1.1.1.1 SEL. CNT. PRINT.

1.1.1.2 PRINT BAND CNT

1.1.1.3 DISC. CNT.PRINT.

1.1.1.4 FAIL. CNT.PRINT.

1.1.1.5 COIN MECH. PRINT

1.1.2 TOTAL PRINTING

1.2 PRINT REL. STAT.

1.2.1 PARTIAL PRINTING

1.2.1.1 SEL. CNT. PRINT.

1.2.1.2 PRINT BAND CNT

1.2.1.3 DISC. CNT.PRINT.

1.2.1.4 FAIL. CNT.PRINT.

1.2.1.5 COIN MECH. PRINT

1.2.2 TOTAL PRINTING

I Statistics

I.1 Printing the Statistics

I.1.1 Partial printout

I.1.1.1 Printing the selection counters

When confirming this function, the counters regarding the different selections are printed.

I.1.1.2 Printing the time band counters

When confirming this function, the counters regarding the different time bands are printed.

I.1.1.3 Printing the discount counters

When confirming this function, the counters regarding discounts and overprice are printed.

I.1.1.4 Printing the failure counters

When confirming this function, the counters regarding the different failure are printed.

I.1.1.5 Printing the coin mechanism data

When confirming this function, the counters regarding the coin mechanism data are printed.

I.1.2 Total printout

When confirming this function, all statistics are printed.

I.2 Printing the relative statistics

I.2.1 Partial printout

I.2.1.1 Printing the selection counters

When confirming this function, the relative counters regarding the different selections are printed.

I.2.1.2 Printing the time band counters

When confirming this function, the relative counters regarding the different time bands are printed.

I.2.1.3 Printing the discount counters

When confirming this function, the relative counters regarding discounts and overprice are printed.

I.2.1.4 Printing the failure counters

When confirming this function, the relative counters regarding failures are printed.

I.2.1.5 Printing the coin mechanism data

When confirming this function, the relative counters regarding the coin mechanism data are printed.

I.2.2 Total printout

When confirming this function, all relative statistics are printed.

1 STATISTICS

1.3 STATIST. DISPLAY

1.3.1 SEL. CNT. DISP.

1.3.1.1 CNT DIS. X 5 SEL.

1.3.1.2 TOT CNT DISPLAY

1.3.1.3 SEL.NO.CNT. DIS.

1.3.2 DISPLAY BAND CNT

1.3.3 DISC. CNT. DISP.

1.3.4 FAIL. CNT. DISP

1.3.5 COIN MECH. DISP.

1.3.5.1 AUDIT DATA DISP.

1.3.5.2 CASH COUNT. DIS.

1.3 Displaying the statistics

1.3.1 Displaying the selection counters

1.3.1.1 Displaying the single counters

This function is used for displaying the counters regarding each selection, divided by price band (0, 1, 2, 3, 4, Free, Test).

1.3.1.2 Displaying the total counters

This function is used for displaying the total counters regarding each selection.

1.3.1.3 Displaying the selection counters in normal vending mode - maintenance - decaffeinated drinks (for Espresso models only)

This function is used for displaying the total counters regarding the selections made while in normal vending mode, maintenance mode, and decaffeinated drinks using the DECAF door (for Espresso models only).

1.3.2 Displaying the time band counters

When selecting the desired price band (0, 1, 2, 3, 4, Free, Test), the total number of selections made for that price band is displayed.

1.3.3 Displaying the discount counters

This function is used for displaying the total amount of discounts and overprice accumulated for the dispensed selections.

1.3.4 Displaying the failure counters

This function is used for displaying the number of times each possible failure occurred in the vending machine.

1.3.5 Displaying the coin mechanism data

1.3.5.1 Displaying the audit data

This function is used for displaying the number of coins inserted in the vending machine, differentiated by the type of coin.

1.3.5.2 Displaying the cashed amount

This function is used for displaying the value of:

- Total cashed
- Total sold
- Total cashed by credit

1 STATISTICS

1.4 DISP. REL. STAT.

1.4.1 SEL. CNT. DISP.

1.4.1.1 CNT DIS. X S.SEL.

1.4.1.2 TOT CNT DISPLAY

1.4.1.3 SEL.NO.CNT. DIS.

1.4.2 DISPLAY BAND CNT

1.4.3 DISC. CNT. DISP.

1.4.4 FAIL. CNT. DISP

1.4.5 COIN MECH. DISP.

1.4.5.1 AUDIT DATA DISP.

1.4.5.2 CASH COUNT. DIS.

1.4 Displaying the relative statistics

1.4.1 Displaying the selection counters

1.4.1.1 Displaying the single counters

This function is used for displaying the counters regarding each selection, divided by price band (0, 1, 2, 3, 4, Free, Test).

1.4.1.2 Displaying the total counters

This function is used for displaying the total counters regarding each selection.

1.4.1.3 Displaying the selection counters in normal vending mode - maintenance - decaffeinated drinks (for Espresso models only)

This function is used for displaying the total counters regarding the selections made while in normal vending mode, maintenance mode, and decaffeinated drinks using the DECAF door (for Espresso models only).

1.4.2 Displaying the time band counters

When selecting the desired price band (0, 1, 2, 3, 4, Free, Test), the total number of selections made for that price band is displayed.

1.4.3 Displaying the discount counters

This function is used for displaying the total amount of discounts and overprice accumulated for the dispensed selections.

1.4.4 Displaying the failure counters

This function is used for displaying the number of times each possible failure occurred in the vending machine.

1.4.5 Displaying the coin mechanism data

1.4.5.1 Displaying the audit data

This function is used for displaying the number of coins inserted in the vending machine, differentiated by the type of coin.

1.4.5.2 Displaying the cashed amount

This function is used for displaying the value of:

- Total cashed
- Total sold
- Total cashed by credit

1 STATISTICS

1.5 DELETE REL. STAT.

1.5.1 PARTIAL RESET

1.5.1.1 SEL. CNT. RESET

1.5.1.2 DISC. CNT. RESET

1.5.1.3 FAIL. CNT. RESET

1.5.1.4 COIN MECH. RESET

1.5.2 TOTAL RESET

1.5 Deleting the relative statistics

1.5.1 Partial delete

1.5.1.1 Deleting the selection counters

When confirming this function, the counters regarding the different selections, described at point 3.4.1, are deleted.

1.5.1.2 Deleting the discount counters

When confirming this function, the counters regarding discounts and overprice, described at point 3.4.2, are deleted.

1.5.1.3 Deleting the failure counters

When confirming this function, the counters regarding the different failures, described at point 3.4.3, are deleted.

1.5.1.4 Deleting the coin mechanism data

When confirming this function, the counters regarding the coin mechanism data, described at point 3.4.4, are deleted.

1.5.2 Total delete

When confirming this function, all relative statistics are deleted.

2 SET INDIV. PRICE

2.1 PRICE BAND 0

2.2 PRICE BAND 1

2.3 PRICE BAND 2

2.4 PRICE BAND 3

2.5 PRICE BAND 4

3 TUBE CONTROL

3.1 FILLING TUBE

3.2 TUBE EMPTYING

4 BOILER TEMPERAT.

2 Setting single prices

Four different prices can be set for each selection according to the programmed time bands, if enabled.

2.1 Price band 0

This function is used for setting the prices for time band 0 (if enabled).

2.2 Price band 1

This function is used for setting the prices for time band 1 (if enabled).

2.3 Price band 2

This function is used for setting the prices for time band 2 (if enabled).

2.4 Price band 3

This function is used for setting the prices for time band 3 (if enabled).

2.5 Price band 4

This function is used for setting the prices for time band 4 (if enabled).

3 Change tubes control

3.1 Filling the change tubes

From this function, the change tubes can be filled manually. Confirm refilling, and the display will indicate "Credit: —" which is the value of money available in change the tubes; insert the desired coin into the validator and the display will indicate the value of money available in the change tubes.

3.2 Releasing the change tubes

From this function, the change tubes can be released manually. When confirming releasing, it will be possible to decide which tube to release. Each time the confirm button is pressed, a coin is ejected from the active tube.

4 Boiler temperature

This function is used for displaying the operating temperature, expressed in °C, of the boiler installed in the machine.

5 TEST

5.1 COMP. DISPENSING

5.2 WATER ONLY

5.3 POWDER ONLY

5 Test

5.1 Complete dispensing

With this function it is possible to obtain, with the door open and without inserting any money, complete dispensing for each selection.

5.2 Dispensing water only

With this function it is possible to dispense, with the door open and without inserting any money, only the water doses for each selection.

5.3 Dispensing powder only

With this function it is possible to dispense, with the door open and without inserting any money, only the powder doses for each selection.

1. FAILURES

1.1 FAILURE READING

WATER FAILURE

WASTE CONTAINER FULL

AIR-BREAK

VOLUMETRIC COUNTER

BOILER

CAN-BUS BOARD

COIN MECHANISM

GRINDER

COFFEE UNIT

NO COFFEE

RAM DATA

I. Failures

I.1 Reading the failures

When the “Failure” function is displayed, press the confirm button “” to display the present failures.

If no failures are currently present, after pressing the confirm button “” the message “End failures” will be displayed.

The possible failures are indicated in the following cases:

Water failure

If the air-break micro-switch is closed for more than one minute, the water inlet solenoid valve will remain energized until the water flow is restored.

Waste container full

The machine locks if the liquid waste container float is triggered.

Air-break

The machine is locked if after 10 selections the micro-switch has never signalled the lack of water.

Volumetric counter

Failed computation of the volumetric counter within a maximum given time.

Boiler

The machine will lock if after the maximum time of heating from the machine start, or from the last selection, the boiler fails to reach the operating temperature.

CAN-BUS board

Failed dialogue between C.P.U. board and CAN-BUS board (Fresh-brew unit control).

Coin mechanism

The machine is locked if it receives a pulse longer than 2 seconds on a validator line or the communication with the serial coin mechanism does not take place for more than 30 seconds (Executive protocol) or 75 seconds (BDV protocol).

Grinder blockage

If the coffee grinder does not rotate or rotates too slowly for longer than 5 seconds, the espresso coffee selections are disabled. Decaffeinated coffee based selections remain available.

Coffee unit

Due to mechanical blocking of the unit. The machine is not locked, but all coffee-based selections are disabled.

No coffee

If the coffee grinder exceeds the speed of 1200 RPM for longer than 5 seconds, the espresso coffee based selections are disabled. Decaffeinated based selections remain available.

RAM Data

One or more areas of the RAM contain wrong data which was corrected with the default values.

The machine will continue to function, but it would be advisable to initialise as soon as possible.

1. FAILURES

1.1 FAILURE READING

FB PISTON

FB SCRAPER

COLD U. PRESS. SWITCH

NO SYRUP 1

NO SYRUP 2

EMPTY CARBONATOR

COLD UNIT COMPRESS.

COLD UNIT BOARD

1.2 FAILURE RESET

FB piston

Due to wrong positioning of the unit. The machine is not locked, but all fresh product based selections are disabled.

FB scraper

Wrong positioning of the grounds ejection scraper. The machine is not locked, but all fresh product based selections are disabled.

Cold unit pressure switch

In the event of lack of pressure from the mains, the machine disables cold drinks selections.

No syrup 1

Locking the relevant selection in the event of lack of syrup.

No syrup 2

Locking the relevant selection in the event of lack of syrup.

Empty carbonator

If the level control device of the carbonator indicates it is empty, cold drink selections are placed out of service.

Cold unit compressor

The machine is locked if the cold unit temperature sensor does not signal a temperature change in 40 hours.

Cold unit board

If there is communication between the cold unit card and the CPU board, the cold drink selections are disabled.

1.2 Resetting the failures

By confirming this function all current failures will be reset

2. SET PARAMETERS

2.1 CASH

2.1.1 PRICES

2.1.1.1 SET INDIV. PRICE

2.1.1.2 SET GLOB. PRICES

2.1.1.3 TIME SCHEDULE

2 Setting the parameters

2.1 Cash

This set of functions controls all parameters regarding the payment systems and the sales prices.

2.1.1 Prices

Four different prices can be set for each selection according to the programmed time bands for when the time table option is enabled.

For each of the 4 time bands prices (0 to 65,535) can be programmed globally (same price for all selections) or for the single selections.

Should the majority of products be sold at the same price, it will be convenient to set the price globally and then change the figure of the selections with different prices.

2.1.1.1 Setting single prices

This function is used for setting a different price for each selection.

2.1.1.2 Setting global prices

This function is used for setting one price for all available selections.

2.1.1.3 Time bands

Four programmable time bands are provided for selling products at different prices.

The time periods are programmable for beginning and end time by hours (00 to 23) and minutes (00 to 59).

If the values for start and end of the time band are set to 00.00 the time period is disabled.

The reference time is kept by an internal clock, programmable as:

day/month/year week-day 1-7 and then hour/minutes/seconds.

If the values for start and end of the time band are set to 00.00 the time period is disabled.

2. SET PARAMETERS

2.1.2 COIN MECHANISM

2.1.2.1 COIN MECH. SET.

EXECUTIVE

VALIDATORS

BDV

2.1.2 Coin mechanisms

2.1.2.1 Setting the coin mechanisms

It is possible to decide which of the payment system protocols available are to be enabled for the functions.

The available payment systems are:

- Executive
- Validators
- BDV
- MDB

By selecting one of the systems it is possible to control its functions.

Executive

The following payments systems are available for the Executive system:

- Standard
- Price Holding
- Coges
- U-Key
- Sida

Validators

When the "Validat. Lines" (line setting) function of the "Technician" menu is displayed, the value of the 6 validator coin lines can be changed.

BDV

The BDV protocol menus are used for defining the following functions:

Type of vending

Setting the operating mode for multiple or single dispensing. With multiple dispensing, the change is not automatically returned after a successful selection; however the credit is available for further selections. When pressing the coin return button, the available credit is returned if its value is lower than the maximum change value.

Credit control

This function enables/disables the return of credit if no selections are made.

If enabled, this function allows the return of coins even if the first selection was not dispensed.

If however a selection fails for any reason, the change will be returned if requested.

Maximum credit

This function is used to define the maximum accepted credit.

Maximum change

It is possible to set a limit to the total amount of change returned by the coin mechanism when pressing the coin return button or after a single dispensing serving.

Any credit exceeding the amount programmed with this function will be cashed.

2. SET PARAMETERS

2.1.2.1 COIN MECH. SET.

BDV

Accepted coins

It is possible to define which, among the coins recognised by the validator, are to be accepted.

Check the label on the coin mechanism for the correct coin to value matching, indicating the position of the coins.

Non accepted coins

This function programs the rejection of coins when in “exact amount” mode.

Check the label on the coin mechanism for the correct coin to value matching, indicating the position of the coins.

Dispensing buttons

This function enables or not the buttons on the coin mechanism used to release the coins in the change return tubes.

Value of “exact amount”

This value defines the combination of empty coin tubes, setting the coin mechanism in “exact amount” mode. The possible combinations of empty coin tubes are indicated below.

For greater simplicity, the combination is described with reference to tubes A, B and C, where tube A receives the lower value coins and tube C the greater value coins.

0	=	A or (B and C)
1	=	A and B and C
2	=	A and B only
3	=	A and (B or C)
4	=	A only
5	=	A or B (default) only
6	=	A or B or C
7	=	A or B only
8	=	A or C only
9	=	B and C only
10	=	B only
11	=	B or C only
12	=	C only

C.P.C. device

It dialogues with the coin mechanism if devices are installed or removed from the serial interface (C.P.C.-type devices - the monitoring unit is always enabled by default).

Minimum level of tubes

It brings forward the “Insert exact amount” message for the user, by adding a number of coins between 0 and 15 to the programmed number of coins, to set the “full change tubes” status.

Free Vend VMC

Most payment systems with the BDV protocol control the free vend function.

However, there are some payment systems without such function.

In this case, if free selections are to be dispensed, free vending must be enabled with VMC (vending machine control, enabled by default) and the price of the selections must be set to zero.

2. SET PARAMETERS

2.1.2.1 COIN MECH. SET.

MDB

MDB

The MDB protocol menus are used for defining the following functions:

Type of vending

Setting the operating mode for multiple or single dispensing. With multiple dispensing, the change is not automatically returned after a successful selection; however the credit is available for further selections. When pressing the coin return button (if the function is enabled), the available credit is returned up to the maximum change value.

Credit control

To enable/disable the operation of the coin return button.

Maximum credit

This function is used to define the maximum accepted credit.

Maximum change

It is possible to set a limit to the total amount of change returned by the coin mechanism when pressing the coin return button or after a single dispensing serving. Any credit exceeding the amount programmed with this function will be cashed.

Accepted coins

It is possible to define which, among the coins recognised by the validator, are to be accepted when the change tubes are full.

Check the coin mechanism configuration for the correct coin to value matching.

Returned coins

It is possible to define which, among the coins available in the tubes, are to be used for returning the change. This parameter is active only with coin mechanisms that do not automatically control the choice of tube to be used (Auto changer payout). Check the coin mechanism configuration for the correct coin to value matching.

Accepted bills

It is possible to define which, among the bills recognised by the reader, are to be accepted.

Check the reader configuration for the correct bill to value matching.

Minimum level of tubes

This function is used for setting the number of coins (0 to 15) to determine the status of full change tubes and the "Insert exact amount" message for the user.

2. SET PARAMETERS

2.1.2.2 IMMEDIATE CHANGE

2.1.3 DECIMAL POINT

Accepted coins with “exact amount”

It is possible to define which, among the coins recognised by the validator, are to be accepted when the machine is in the “exact amount” condition.

Check the coin mechanism configuration for the correct coin to value matching.

Accepted bills with “exact amount”

It is possible to define which, among the bills recognised by the accepter, are to be accepted when the machine is in the “exact amount” condition.

Check the accepter’s configuration for the correct bill to value matching.

2.1.2.2 Immediate change

Normally, the amount of a selection is cashed after the machine sends the message “Selection successful”.

When this function is enabled, disabled by default, the cash message is sent at the beginning of dispensing.

2.1.3 Decimal point.

Press the confirm button “” to display the position of the decimal point, i.e.:

0	decimal point disabled
1	XXX.X
2	XX.XX
3	X.XXX

Press the confirm button “”, these values will start blinking and can then be modified as necessary.

Some protocols insert the decimal point automatically, in such case the programmed value does not have any effect.

2. SET PARAMETERS

2.2 SELECTIONS

2.2.1 SET WATER

2.2.1.1 WATER DOSES

2.2.1.2 SET WHIPPER

2.2.1.2.1 SET WHIP DOSES

2.2.1.2.2 SET MODALITY

2.2.1.3 EL VALVE SETTING

2.2 Selections

2.2.1 Setting the water

2.2.1.1 Water doses

With this function the water dose can be set for each selection button, expressed in:

- **cc** for Fresh-Brew and Instant models
- **flow-meter pulses** for Espresso models

the display will indicate the name of the product being set for each product included in the selection.

2.2.1.2 Setting the whipper

2.2.1.2.1 Setting the whipper doses

The whipping time can be set for each selection button, for each water dose that composes such selection.

The duration can be set in two different modes:

2.2.1.2.2 Setting the whipper mode

It is possible to choose between two different modes:

Absolute

i.e. independent from the solenoid valve opening time. The whipping duration is set as tenths of a second for Instant models and as volumetric counter pulses for Espresso models.

Relative

i.e. based on the difference, plus or minus, from the moment the solenoid valve closes.

The whipping duration is always expressed in tenths of a second.

2.2.1.3 Solenoid valve settings

It is possible to set the water flow rate of the single solenoid valves expressed in cc/s (the default value setting in cc/s is indicated in the selection dose table) to calculate the amount of water to be dispensed in Fresh-Brew and Instant models.

2. SET PARAMETERS

2.2.2 SET POWDER

2.2.2.1 POWDER DOSES

2.2.2.2 DOSER SETTING

2.2.3 SELECTION STATUS

2.2.4 SEL. <-> BUTTON

2.2.5 CHECK NO. SELEC.

2.2.2 Setting the powders

2.2.2.1 Powder doses

The powder dose expressed in grams can be set for each selection button, for each product that composes such selection.

2.2.2.2 Setting the doser units

This function is used for setting the flow rate of the single doser units, expressed in g/s, to calculate the amount of powder to be dispensed, for correct conversion of product dose values.

2.2.3 Selection status

Each single selection button can either be enabled or disabled.

2.2.4 Button <-> Selection

This function permits the association of a selection number, indicated in the selection dose table, to a button in the direct selection keypad.

2.2.5 Checking the selection number

Verifying the selection number associated to a button.

2. SET PARAMETERS

2.3 MACHINE PARAM.

2.3.1 BOILER TEMPERAT.

2.3.2 TANK

2.3.3 ENAB.FLUSHBUTTON

2.3.4 TUBES OK?

2.3.5 BUZZER ENABLE

2.3.6 MAINT.DISP.SETT.

2.3.7 ENAB.AUTOM.FLUSH

2.3 Machine parameters

2.3.1 Boiler temperature

This function is used for setting the operating temperature, expressed in °C, of the boiler installed in the machine. After selecting the boiler, press the confirm button “**↵**”, the temperature value on the display will start blinking and can be modified as necessary.

2.3.2 Tank

The machine water supply can be from the mains or from an internal tank. With this function it is possible to define whether the machine water supply is from the mains (tank = 0) or from the tanks (tank = 1).

2.3.3 Enabling the wash button

With this function it is possible to enable the operation of the mixer wash button. Normally the button is disabled.

2.3.4 Enabling the confirm messages at power-on

This function is used for enabling or disabling the confirm messages at machine power-on, reminding the user of having correctly positioned the:

- Tubing
- Mixers
- Powder feeder

The function is set to OFF by default.

2.3.5 Enabling the buzzer

With this function it is possible to enable the electric buzzer sound (if installed). This function is disabled by default.

2.3.6 Setting dispensing in maintenance mode

After a programmable number of dispensed drinks, it is possible to display the message “**Regenerate the water softener**” upon accessing “Filler menu” mode.

2.3.7 Enabling automatic wash

Option of setting the time when automatically cleaning the mixers and rotating the brewing units installed. When setting the time to 24.00 the function is disabled (default).

2. SET PARAMETERS

2.3.8 ENERGY SAVING

2.3.8.1 SET ENERGY SAV.

2.3.8.2 ENERGY SAV. PAR.

2.3.9 DEC. CYCLE

2.3.a EQ. CABINET

2.3.b COUNTER MAX NO.

2.3.8 Energy saving

This function is used for saving electric power when the machine is not in use.

2.3.8.1 Setting the energy saving

This function is used for enabling or disabling the automatic switch-off of the vending machine boiler during the time when it is believed the machine would not be used.

2.3.8.2 Energy saving parameters

This function is used for setting the days of the week (1 Monday, 2 Tuesday, 3 Wednesday, etc.) and the time bands (band 1 and 2) when the boiler is to be switched off for energy saving.

2.3.9 Decaffeinated cycle

When enabling this function, instant coffee powder (if present) is dispensed in two steps to improve the appearance of the drink.

2.3.a Equipped base cabinet

When this function is enabled, the machine is configured for operation with an equipped base cabinet, i.e. with water supply from a tank inside the base cabinet and control of the liquid waste container float.

2.3.b Counter maximum number

This function is used for setting the maximum number of selections to be reached for the purpose of disabling the machine. The counters can be set for the following selections:

- Espresso
- Instant
- Espresso + Instant

The number of selections made is reset automatically when a new value is set for the counter.

This function is not active if the counter reset password was not previously set in the Technician menu 2.6.3.3

2. SET PARAMETERS

2.4 DISPLAY

2.4.1 LANGUAGE

2.4.2 PROMO. ADVERT.

2.4.2.1 ENABLE PR. ADV.

2.4.2.2 SET PROMO. ADV.

2.4 Display

2.4.1 Language

It is possible to choose which of the following languages, available in the software, is to be used for the messages on the display:

- Italian
- English
- French
- Spanish
- German
- Danish

2.4.2 Promotional message

2.4.2.1 Enabling the promotional message

This function is used for enabling or disabling a promotional message appearing on the display during the machine normal vending mode.

2.4.2.2 Setting the promotional message

This function is used for writing the 2-line promotional message; by pressing the confirm button "↵" the first character starts blinking; this can then be changed using the "↑" and "↓" buttons, scrolling through the available characters.

Once the message is completed, it can be stored by pressing button "←".

2. SET PARAMETERS

2.5 PRE-SELECTIONS

2.5.1 WATER +

2.5.1.1 SELECTION ENABL.

2.5.1.2 DOSE VARIATION

2.5.1.3 PRICE VARIATION

2.5.2 WATER -

2.5.3 STRONG

2.5.4 MILD

2.5.5 POWDER COFFEE

2.5.6 EXTRA MILK

2.5.7 MOCHA

2.5 Pre-selections

This function is used for setting the pre-selections present in specific this model and layout, enabling or disabling the pre-selection for a certain selection, changing dose and price. An example for the first pre-selection is indicated below; the operations to be carried out are identical for each selection.

2.5.1 Water +

2.5.1.1 Enabling the selection

Press the confirm button to select the selection button for which the pre-selection is to be enabled.

2.5.1.2 Changing the dose

This function is used for changing the product percentage dispensed with the pre-selection.

2.5.1.3 Changing the price

This function is used for assigning a discount or overprice to the selection set with the pre-selection.

2. SET PARAMETERS

2.6 MISCELLANEOUS

2.6.1 FB DATA

2.6.2 JUG FACILITIES

2.6.3 PASSWORD

2.6.3.1 SET PASSWORD

2.6.3.2 ENABLE PASSWORD

2.6.3.3 COUNT. RESET PWD

2.6.3.4 JUG FACILITY PWD

2.6 Miscellaneous

2.6.1 Fresh-brew unit data

For the Fresh-brew unit it is possible to set the brewing time, the drying time for the used dose and the extraction pressure.

2.6.2 Jug facilities

This function is used for setting the number of consecutive selections (1 to 9; 5 by default) without cup to fill a jug.

2.6.3 Password

This function is used for setting the passwords concerning the functions described below. These passwords are disabled by setting the value to 0000.

2.6.3.1 Setting the password

Enter a 5-digit numeric code to be set as password to access the "Technician menu" mode..

2.6.3.2 Enabling the password

This function is used for enabling or disabling the password request when accessing the "Technician menu" mode (disabled by default).

2.6.3.3 Counter reset password

This function is used for setting the password for resetting the counters set in the Technician menu 2.3.b

2.6.3.4 Jug facility password

This function is used for setting the password for switching the machine to jug facility mode.

2. SET PARAMETERS

2.6.3.5 FREE VENDING PWD

2.6.3.5 Free vending password

This function is used for setting the password for switching the machine to free vending mode.

2.6.3.6 KEYPAD LOCK PWD

2.6.3.6 Keypad lock password

This function is used for setting the password in order to lock the selection keypad until the password is entered again.

2.6.3.7 WASH PWD

2.6.3.7 Wash password

This function is used for setting the password for switching the machine to free vending mode.

2.6.3.8 TEST SEL. PWD

2.6.3.8 Test selection password

This function is used for setting the password to access the “Programming menu” mode and therefore also the test selections made from the outside.

2.6.4 ENABLE FILL MENU

2.6.4 Enabling the Filler menu

This function is used for determining which of the “Filler menu” functions are to be left active and which are to be disabled. The reference numbers of the menus do not change even if some are disabled.

3. STATISTICS

3.1 ELECTR. COUNTER

3.1.1 DISPLAY COUNTERS

3.1.2 RESET COUNTER

3.2 STATIST. DISPLAY

3.2.1 SEL. CNT. DISP.

3.2.1.1 CNT DIS. X S.SEL.

3.2.1.2 TOT CNT DISPLAY

3.2.1.3 SEL.NO.CNT. DIS.

3.2.2 DISPLAY BAND CNT

3.2.3 DISC. CNT. DISP.

3.2.4 FAIL. CNT. DISP.

3 Statistics

3.1 Electronic counter

3.1.1 Displaying the selection counters

This function is used for displaying the total number of selections dispensed by the vending machine.

3.1.2 Resetting the counters at power-on

This function is used for resetting the general selection counter.

3.2 Displaying the statistics

3.2.1 Displaying the selection counters

3.2.1.1 Displaying the single counters

This function is used for displaying the counters regarding each selection, divided by price band (0, 1, 2, 3, 4, Free, Test).

3.2.1.2 Displaying the total counters

This function is used for displaying the total counters regarding each selection.

3.2.1.3 Displaying the selection counters in normal vending mode - maintenance - decaffeinated drinks (for Espresso models only)

This function is used for displaying the total counters regarding the selections made while in normal vending mode, maintenance mode, and decaffeinated drinks using the DECAF door (for Espresso models only).

3.2.2 Displaying the time band counters

When selecting the desired price band (0, 1, 2, 3, 4, Free, Test), the total number of selections made for that price band is displayed.

3.2.3 Displaying the discount counters

This function is used for displaying the total amount of discounts and overprice accumulated for the dispensed selections.

3.2.4 Displaying the failure counters

This function is used for displaying the number of times each possible failure occurred in the vending machine.

3. STATISTICS

3.2.5 COIN MECH. DISP.

3.2.5.1 AUDIT DATA DISP.

3.2.5.2 CASH COUNT. DIS.

3.3 STATISTICS RESET

3.3.1 PARTIAL RESET

3.3.1.1 SEL. CNT. RESET

3.3.1.2 DISC. CNT. RESET

3.3.1.3 FAIL. CNT. RESET

3.3.1.4 COIN MECH. RESET

3.3.2 TOTAL RESET

3.2.5 Displaying the coin mechanism data

3.2.5.1 Displaying the audit data

This function is used for displaying the number of coins inserted in the vending machine, differentiated by the type of coin.

3.2.5.2 Displaying the cashed amount

This function is used for displaying the value of:

- Total cashed
- Total sold
- Total cashed by credit

3.3 Deleting the statistics

3.3.1 Partial delete

3.3.1.1 Deleting the selection counters

When confirming this function, the counters regarding the different selections, described at point 3.2.1, are deleted.

3.3.1.2 Deleting the discount counters

When confirming this function, the counters regarding discounts and overprice, described at point 3.2.2, are deleted.

3.3.1.3 Deleting the failure counters

When confirming this function, the counters regarding the different failures, described at point 3.2.3, are deleted.

3.3.1.4 Deleting the coin mechanism data

When confirming this function, the counters regarding the coin mechanism data, described at point 3.2.4, are deleted.

3.3.2 Total delete

When confirming this function, all statistics are deleted.

3. STATISTICS

3.4 DISP. REL. STAT.

3.4.1 SEL. CNT. DISP.

3.4.1.1 CNT DIS. X S. SEL.

3.4.1.2 TOT CNT DISPLAY

3.4.1.3 SEL.NO.CNT. DIS.

3.4.2 DISPLAY BAND CNT

3.4.3 DISC. CNT. DISP.

3.4.4 FAIL. CNT. DISP

3.4.5 COIN MECH. DISP.

3.4.5.1 AUDIT DATA DISP.

3.4.5.2 CASH COUNT. DIS.

3.4 Displaying the relative statistics

3.4.1 Displaying the selection counters

3.4.1.1 Displaying the single counters

This function is used for displaying the counters regarding each selection, divided by price band (0, 1, 2, 3, 4, Free, Test).

3.4.1.2 Displaying the total counters

This function is used for displaying the total counters regarding each selection.

3.4.1.3 Displaying the selection counters in normal vending mode - maintenance - decaffeinated drinks (for Espresso models only)

This function is used for displaying the total counters regarding the selections made while in normal vending mode, maintenance mode, and decaffeinated drinks using the DECAF door (for Espresso models only).

3.4.2 Displaying the time band counters

When selecting the desired price band (0, 1, 2, 3, 4, Free, Test), the total number of selections made for that price band is displayed.

3.4.3 Displaying the discount counters

This function is used for displaying the total amount of discounts and overprice accumulated for the dispensed selections.

3.4.4 Displaying the failure counters

This function is used for displaying the number of times each possible failure occurred in the vending machine.

3.4.5 Displaying the coin mechanism data

3.4.5.1 Displaying the audit data

This function is used for displaying the number of coins inserted in the vending machine, differentiated by the type of coin.

3.4.5.2 Displaying the cashed amount

This function is used for displaying the value of:

- Total cashed
- Total sold
- Total cashed by credit

3. STATISTICS

3.5 DELETE REL. STAT.

3.5.1 PARTIAL RESET

3.5.1.1 SEL. CNT. RESET

3.5.1.2 DISC. CNT. RESET

3.5.1.3 FAIL. CNT. RESET

3.5.1.4 COIN MECH. RESET

3.5.2 TOTAL RESET

3.6 EM. CNT AT START

3.7 STATIS. PRINTING

3.7.1 PARTIAL PRINTING

3.7.1.1 SEL. CNT. PRINT.

3.7.1.2 PRINT BAND CNT

3.7.1.3 DISC. CNT.PRINT.

3.7.1.4 FAIL. CNT.PRINT.

3.7.1.5 COIN MECH. PRINT

3.5 Deleting the relative statistics

3.5.1 Partial delete

3.5.1.1 Deleting the selection counters

When confirming this function, the counters regarding the different selections, described at point 3.4.1, are deleted.

3.5.1.2 Deleting the discount counters

When confirming this function, the counters regarding discounts and overprice, described at point 3.4.2, are deleted.

3.5.1.3 Deleting the failure counters

When confirming this function, the counters regarding the different failures, described at point 3.4.3, are deleted.

3.5.1.4 Deleting the coin mechanism data

When confirming this function, the counters regarding the coin mechanism data, described at point 3.4.4, are deleted.

3.5.2 Total delete

When confirming this function, all relative statistics are deleted.

3.6 Enabling the counters at power-up

By enabling this function, it is possible to display the total counters at machine power-on.

3.7 Printing the Statistics

3.7.1 Partial printout

3.7.1.1 Printing the selection counters

When confirming this function, the counters regarding the different selections are printed.

3.7.1.2 Printing the time band counters

When confirming this function, the counters regarding the different time bands are printed.

3.7.1.3 Printing the discount counters

When confirming this function, the counters regarding discounts and overprice are printed.

3.7.1.4 Printing the failure counters

When confirming this function, the counters regarding the different failure are printed.

3.7.1.5 Printing the coin mechanism data

When confirming this function, the counters regarding the coin mechanism data are printed.

3. STATISTICS

3.7.2 TOTAL PRINTING

3.8 PRINT REL. STAT.

3.8.1 PARTIAL PRINTING

3.8.1.1 SEL. CNT. PRINT.

3.8.1.2 PRINT BAND CNT

3.8.1.3 DISC. CNT.PRINT.

3.8.1.4 FAIL. CNT.PRINT.

3.8.1.5 COIN MECH. PRINT

3.8.2 TOTAL PRINTING

3.7.2 Total printout

When confirming this function, all statistics are printed.

3.8 Printing the relative statistics

3.8.1 Partial printout

3.8.1.1 Printing the selection counters

When confirming this function, the relative counters regarding the different selections are printed.

3.8.1.2 Printing the time band counters

When confirming this function, the relative counters regarding the different time bands are printed.

3.8.1.3 Printing the discount counters

When confirming this function, the relative counters regarding discounts and overprice are printed.

3.8.1.4 Printing the failure counters

When confirming this function, the relative counters regarding failures are printed.

3.8.1.5 Printing the coin mechanism data

When confirming this function, the relative counters regarding the coin mechanism data are printed.

3.8.2 Total printout

When confirming this function, all relative statistics are printed.

4. TEST

4.1 TEST DISPENSING

4.1.1 COMP. DISPENSING

4.1.2 WATER ONLY

4.1.3 POWDER ONLY

4.2 SPECIAL FUNCT.

4.2.1 ESPR. UNIT ROTAT.

4.2.2 RELEASE DOSE

4.2.3 EMPTY ES. BOILER

4.2.4 MANUAL INSTALL.

4.2.5 FRESH BREW UNIT

4. Test

4.1 Test dispensing

4.1.1 Complete dispensing

With this function it is possible to obtain, with the door open and without inserting any money, complete dispensing for each selection.

4.1.2 Dispensing water only

With this function it is possible to dispense, with the door open and without inserting any money, only the water doses for each selection.

4.1.3 Dispensing powder only

With this function it is possible to dispense, with the door open and without inserting any money, only the powder doses for each selection.

4.2 Special functions

4.2.1 Unit rotation

This function is used for operating the espresso brewer unit (if fitted).

4.2.2 Releasing a dose

This function is used for starting the grinding of a coffee dose.

4.2.3 Emptying the boiler

This function is used for opening a solenoid valve to allow the intake of air in the event of emptying the boiler for maintenance.

4.2.4 Manual installation

This function is used for manually installing the boiler.

4.2.5 Fresh-brew unit

This function is used for operating the Fresh-brew unit.

4.3 Autotest

This function allows testing, in a semiautomatic way, of the main machine components.

When pressing the confirm button, the message "AUTOTEST" will be start blinking.

It is possible to cancel each operation and go to the next one by pressing the exit button, but confirming with the confirm button to start the autotest routine.

Some checks occur automatically, others need the manual operation of the monitored component.

In a sequence:

- the mixers are activated for 2 seconds
- the mixers are activated for 2 seconds
- rotation of the brewer unit
- wash button; the machine awaits until the button is pressed.
- waste container switch; the machine awaits until the waste container micro-switch is manually operated
- push-button panel test; the machine will display the number of the button which must be pressed and awaits the actuation before going to the next button
- boiler temperature reading
- triggering of a sound signal
- coin mechanism test; checking that communication with the coin mechanism takes place correctly and which validator lines are set as being active.

5 MISCELLANEOUS

5.1 D.A. REGISTRY

5.1.1 INSTALL. DATE

5.1.2 PROG. M/C CODE

5.1.3 OPER. CODE ENTRY

5.2 INITIALISING DB

5 Miscellaneous

5.1 Vending machine information

5.1.1 Installation date

This function is used for storing the current date of system as installation date of the vending machine. This date will be indicated on the statistics printout.

5.1.2 Setting the machine code

This function is used for changing the 8-digit numeric code identifying the machine (set to 0 by default).

5.1.3 Setting the operator code

This function is used for changing the 6-digit numeric code identifying the group of machines (set to 0 by default).

5.2 Initialising the data-base

This function is used for “initialising” the machine, resetting all data to default values. This function should be used if there is a memory data error or when the software is replaced. Except for the general electronic counter, all statistical data is reset. When confirming this function some parameter settings are requested, and namely:

- COUNTRY

Intended as type of basic doses for the different selections. The available “countries” vary according to the models.

- LAYOUT

A number of Button/Selection combinations to choose from is provided for each dose type model (the combinations available for each layout are indicated in the dose selection table supplied with the machine).

- TANK

Defining whether the water supply is:

OFF - from the mains

ON - from an internal/external tank

When confirming the options the message “Working” is displayed for a few seconds.